

NIQ No: IITT/PC/NIQ/44/2022-23

DATE: 15.09.2022

Notice Inviting Quotation

IIT Tirupati hereby invites paraffin wax-sealed quotations for the work mentioned below up to 3.00 PM on 23.09.2022 from eligible contractors/agencies with similar work experience in civil works. The quotations will be opened at 3.30 PM on the same day.

Name of the work: Laying of Irrigation line for Horticulture works at IIT Tirupati, Merlapaka Village, Yerpedu mandal, A.P.

Estimate Cost: 9,62,900/- (Including GST)

Terms and Conditions:

1. IIT-Tirupati shall make no advance payment.
2. The time for completion of works shall be **30 days** from the date of placing the confirmed order by IIT-Tirupati. The act of backing out after quotation will debar such agencies for participating in future quotations of IIT Tirupati. Bidder may email queries to eu@iittp.ac.in or submit to IIT –Tirupati office in hard copy on all working days before the day of the last date of submission of quotation.
3. The blank quotation can be obtained from the IIT Tirupati website <https://iittp.ac.in/tenders>
4. All agencies need to submit their quotation in hard copy in a **paraffin wax-sealed** Envelope to this office by suitable means on and before 3.00 PM on 23.09.2022. The quotation received after the date & time specified above shall not be accepted. Any delays, postal delays, etc., will not be entertained. Agency should quote for all the items in the BOQ. The bid shall be submitted in the original bid document (as issued by the IIT Tirupati), super scribing the name of the work. Quotations will be opened on the same day, i.e., 23.09.2022 at 3.30 PM, in the presence of the bidder or their authorized representatives, if any. The offer of the firm should be commercially clear, including acceptance of all terms and conditions without assigning any reasons.
5. Without the paraffin wax-sealed quotation shall be treated as invalid.
6. Quoted rates should be inclusive of the cost of all the materials, labor, octroi duties, cost of sample, and fees towards testing of materials in labs, royalties, etc., complete. Nothing extra shall be paid.
7. All approved makes shall be as specified in BOQ and CPWD specifications; the agency should put up technical data and obtain prior approval on makes of various materials of IIT Tirupati before taking up work.
8. The successful agency shall make its own arrangement for all Tools & tackles for work etc., complete in view of the completion of work. Electricity shall be provided free of cost to an agency at one source, and the agency should make its own arrangement to tap power from a source to a work location safely.

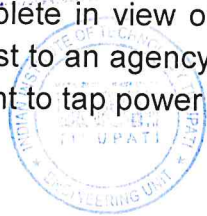

9. TDS and other applicable taxes and cess will be deducted from the bills as of the work.
10. Specification for the work to be carried out as per BOQ, latest CPWD specification, IS specification & as per instruction of IIT Tirupati wherever CPWD/IS specifications are not available.
11. The contractor shall ensure that minimum wages should be paid to the labourers and employees in accordance with labour laws.
12. Agency to submit computerized measurement and abstract sheet to IIT Tirupati for payments.
13. Amount quoted for items should be as specified in the BOQ
14. Following the latest developments and restrictions imposed in the country and state in view of the COVID-19, the agency should have strict compliance with the rules and precautionary measures mentioned in the state government's orders from time to time. The submission of bids should be in the tender box placed at the main gate of the institute. Also, the successful agency should ensure all safety precautions and social distancing norms during the execution of work.
15. The contractor shall submit a sealed quotation with a covering letter (Neatly typed) on their Letter Head. **Without submitting the covering letter, the quotation shall be treated as invalid.**
16. The contractor should mention the Name of the work and the Address of the Contract Agencies on their sealed Envelope.
17. A Blacklisted contractor or a contractor who has not executed the previous works for IIT-TIRUPATI to a satisfactory level is not eligible for participation in this tender. The tender submission by such a contractor will not be accepted.
18. The contractor should send a sealed envelope to the following address
**The Head, Engineering Unit,
Indian Institute of Technology Tirupati,
Engineering unit, South Campus,
Venkatagiri road, Yerpedu Mandal,
Tirupati District, Andhra Pradesh-517619.**

Encl: 1. Annexure-I & Schedule of quantity-as per Annexure-II

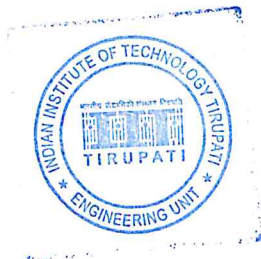

15/09/22
Head, Engineering Unit
Head, Engineering Unit
Indian Institute of Technology Tirupati

Annexure-1**Name of the work: Laying of Irrigation line for Horticulture works at IIT Tirupati, Merlapaka Village, Yerpedu mandal, A.P.****NIQ NO:IITT/PC/NIQ/44/2022-23**

S.No	Name of the Work	Estimated Cost in Rupees	% of Quoted	Excess/less	Total Amount in Rupees	Total Amount in Words
1	Laying of Irrigation line for Horticulture works at IIT Tirupati, Merlapaka Village, Yerpedu mandal, A.P.	9,62,900				

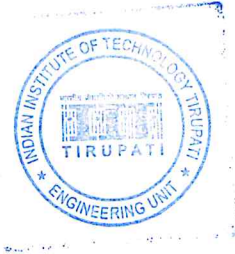

Annexure-2

Name of work:- Laying of Irrigation line for Horticulture works at IIT Tirupati, Merlapaka Village, Yerpedu mandal,

S.No	Description of Work	Unit	Qty
1	Providing & fixing of HD Polyethyelene pipes of approved make, PN* pressure classification pipe including all fittings like tees,elbows,bends etc. The quoted rate shall include any pipe nipples along with SS aligator clamps for inter connecting of pipes if required. Jointing shall be by mirror welding or the wise mentioned as per standerds to ensure water tight joints		
a	50mm HDPE pipe	M	1408
b	32mm HDPE pipe	M	1500
2	Providing & fixing Chlorinated Polyvinyl Chloride(CPVC) pipes, having thermal stability for hot and cold water supply including all CPVC plain and Brass threaded fittings.		
a	25mm CPVC pipe	M	450
3	Providing & fixing ball valve (brass) or approved quality, high or Low pressure, with plastic floats complete 28mm normal hole.		
a	25mm ball valve	Nos	700
4	Earth work in excavation by mechanical means (Hydraulic excavator)/ manual means in foundation trenches or drains (not exceeding 1.5m in width or 10 sqm on plan), including getting out the excavated soil and disposal of surplus excavated soil as directed, with in all leads of 50m.	Cum	873

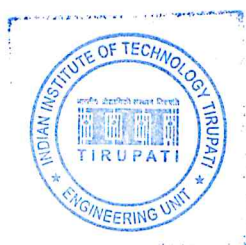

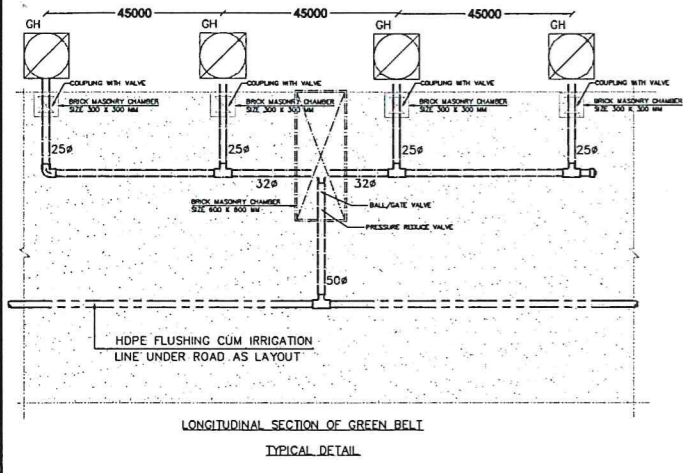

NOTE: ALL GARDEN HYDRANT TAP SHALL BE 25# MM

FLUSHING/IRRIGATION OHT	
PHASE-1	125(KL)
PHASE-2	175(KL)
PHASE-3	175(KL)

FLUSHING/IRRIGATION OHT	
PHASE-1	200(KL)
PHASE-2	300(KL)
PHASE-3	300(KL)

TREATED WATER UGR	
PHASE-1	600(KL)
PHASE-2	900(KL)
PHASE-3	900(KL)

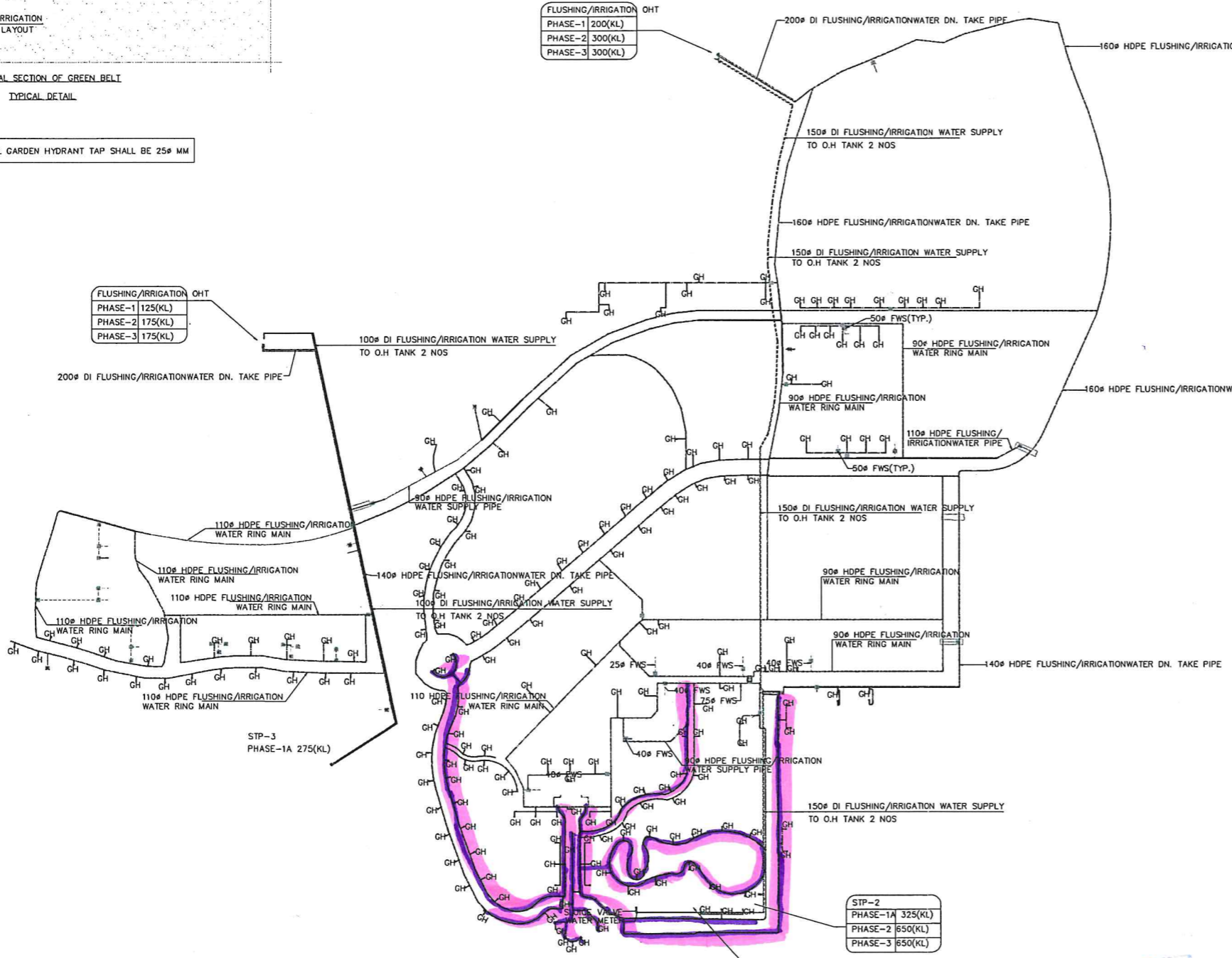

Flushing/Irrigation main supply Line	---
Flushing/Irrigation Ring Main Line	---
Flushing sub connection Line	---
Flushing inter connection Line	---
Flushing Water PRM Lines(DI PIPE)	---
Valve Chamber with Water Meter	⊗
Pressure Reducing Valve (PRV)	⊗
Isolation Valve (ISO)	⊗

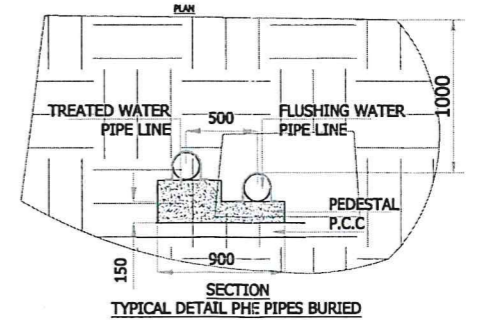
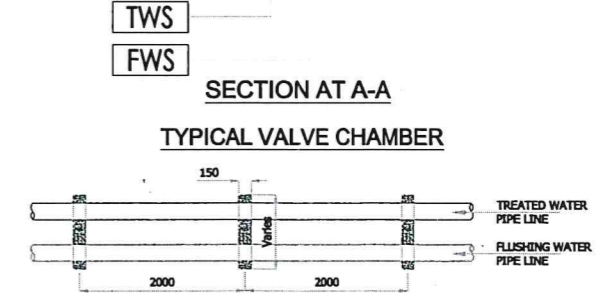
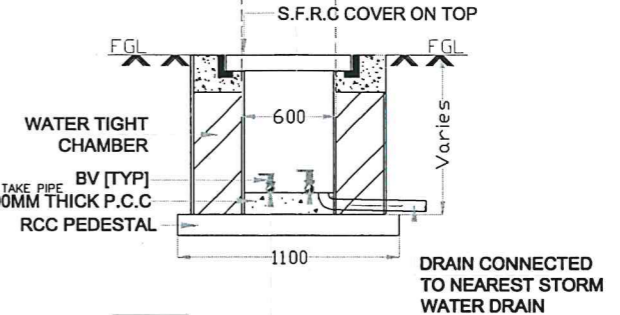
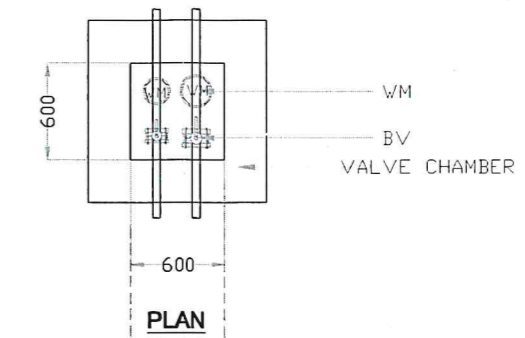

- NOTES**
- 02 NOS. OVER HEAD FLUSHING WATER TANK SHALL BE IN THE SCOPE OF EPC TENDER. (01 NO. FOR ACADEMIC & HOSTEL ZONE AND ANOTHER FOR HOUSING ZONE) FOR STORAGE CAPACITY AND RELATED DETAILS, REF. GFC DRAWING & TENDER SPEC.
 - THE TREATED WATER FROM STP, SHALL BE PUMPED TO OVER-HEAD FLUSHING TANK.
 - WATER FROM OH FLUSHING TANK SHALL BE TRANSFERRED TO FLUSHING TANK AT TERRACE LEVEL OF INDIVIDUAL BUILDINGS, THROUGH GRAVITY
 - THE LEVEL FOR LAYING OF FLUSHING PIPE LINES SHALL BE AS PER EXISTING SITE CONDITION
 - THE TYP. DETAIL OF BURIED TREATED WATER & FLUSHING WATER LINES ARE SHOWN, TO BE FOLLOWED

- GENERAL NOTES**
- THIS DRAWING SHALL BE READ IN CONJUNCTION WITH ARCH PLANS & ARCH DETAILS ALONG WITH OTHER RELEVANT SERVICES DRAWING.
 - THIS DRAWING HAS THE COPYRIGHT OF THE ARCHITECT AND MAYBE USED OR REPRODUCED ONLY WITH HIS PRIOR PERMISSION
 - THE DRAWING IS TO BE READ AND NOT SCALED
 - ALL DIMENSIONS ARE IN MILLIMETERS UNLESS NOTED OTHERWISE
 - ANY DISCREPANCY IN THE DRAWING HAS TO BE IMMEDIATELY BROUGHT TO THE NOTICE OF THE ARCHITECT.

LEGEND

01A	MAIN GATE COMPLEX
01B	SERVICE GATE
01C	SOUTH GATE
01D	NORTH GATE
02A	ADMINISTRATIVE BLOCK
02B	ENGINEERING UNIT OFFICE
03A	DEPARTMENT BLOCK-01
03B	DEPARTMENT BLOCKS- 03 & 04 (PHASE 1-STAGE 2)
04A	LECTURE HALL COMPLEX-01
04B	LECTURE HALL COMPLEX-02
04C	LECTURE HALL COMPLEX-03
05	DEPARTMENT BLOCK-02
06	CENTRAL INSTRUMENTATION AND FACULTY
07	AUDITORIUM
08	LIBRARY
09	WORKSHOP
10	SCIENCE, MATHEMATICS & HUMANITIES DEPT.
11	HOSTEL & DINING BLOCK
11A	BOYS' HOSTEL BLOCK
11B	GIRLS' HOSTEL BLOCK
11C	DINING BLOCK
11D	STUDENTS UTILITY BLOCK
12	VISITORS HOSTEL
13	DIRECTOR RESIDENCE
14	FACULTY HOUSING
14B	TYPE - B (HOUSING)
14C	TYPE - C (HOUSING)
14D	TYPE - D (HOUSING)
14E	TYPE - E (HOUSING)
14F	TYPE - F (HOUSING)
15	DRAW AIR THEATER
16	INDOOR GAMES FACILITY
17	FOOT BALL GROUND
18	CRICKET FIELD
19	HOCKEY GROUND
20	COMMUNITY CENTER
21	CHECHE
22	SCHOOL (K.V.)
23	POST OFFICE, SHOPPING, BANK
24	HEALTH CENTER
25	BUS YARD & WORKSHOP
26	EXISTING ORCHARD (MANGO)
27	WATER BODY / POND
28	SOLID WASTE
29	RAW & DOMESTIC WATER STORAGE WITH PUMP ROOM
30	STP
31	TRANSIT CAMPUS
32	UNDERPASS / CONNECTIVITY
33A	TREATED WATER O.H. TANK
33B	FLUSHING WATER O.H. TANK
34	ESS
35	H & MZ PLANT
36	SPORTS UTILITY BLOCK

BN	SYMBOL	PHASE
01.	[Symbol]	PHASE 1- STAGE-1C
02.	[Symbol]	PHASE 1- STAGE-1B
03.	[Symbol]	PHASE 1- STAGE-1A (TRANSIT CAMPUS)
04.	[Symbol]	FUTURE PHASE

DATE	REV.	REVISION	DESCRIPTION
20.11.2022	R1	IT	MODIFIED AS PER SUGGESTIONS RECEIVED FROM HORTICULTURE OFFICER AT CHENNAI BLUE 2022
20.11.2022	R2	IT	MODIFIED AS PER UPDATED ROAD LAYOUT & LEVEL IN RESIDENTIAL LANE
15.12.2020	R1	IT	GENERAL NOTES ADDED

- PHE & FIRE FIGHTING SUB CONSULTANT :**
Er. A.K. Roy | SGA
 Email: mail@sgadesignlab.com
 ravi@sgadesignlab.com
- HVAC SUB CONSULTANT :**
Er. Ajay Raj | SGA
 Email: mail@sgadesignlab.com,
 ravi@sgadesignlab.com
- ELECTRICAL SUB CONSULTANT :**
Er. S Singh, | SGA
 Email: mail@sgadesignlab.com,
 ravi@sgadesignlab.com

STRUCTURAL SUB CONSULTANT
JEHOVAH KING ENGINEERING CONSULTANTS PVT. L
 Guindy, Chennai -600 032
 Phone: +91 44 22500120

ARCHITECTS
SURESH GOEL & ASSOCIATES
 ARCHITECTS & ENGINEERS & PLANNERS
 C-85, SHIVALKI, NEW DELHI-110017
 TEL: (011) 41034430, 29678254, MAIL:mail@sgadesignlab.com

EXECUTING AGENCY
C.P.W.D., IIT TIRUPATI PROJECTS DIVISION
 ANDHRA PRADESH

CLIENT
INDIAN INSTITUTE OF TECHNOLOGY TIRUPATI
 YERPEDU, ANDHRA PRADESH - 577619

PROJECT TITLE :
DESIGN PACKAGE 1
PHASE 1 (STAGE- 1C), IIT TIRUPATI

STAGE
GOOD FOR CONSTRUCTION

BUILDING TYPE:
MASTER PLAN

DRAWING TITLE
FLUSHING CUM GARDENING
WATER SUPPLY LAYOUT

DRAWING No.
17009-MP-S6-GHY-001

DRAWN BY : AKS	CHECKED BY : KKG	APPROVED BY : JB
SCALE	Revision	Issue Date

